

### POWER MANAGEMENT

#### Description

The SC1565 is a high performance positive voltage regulator designed for use in applications requiring very low dropout voltage at up to 1.5 Amps. Since it has superior dropout characteristics compared to regular LDOs, it can be used to supply 2.5V on motherboards or 2.8V on peripheral cards from the 3.3V supply thus allowing the elimination of costly heatsinks. Additionally, the 5-lead TO-220/TO-263 and SO-8 versions have an enable pin to further reduce power dissipation while shut down. The SC1565 provides excellent regulation over variations in line, load and temperature.

The SC1565 is available in SO-8, 3-lead SOT-223, 3 and 5 lead TO-220 and 3 and 5 lead TO-263 packages. Three lead packages are available with 1.8V and 2.5V fixed output options only. The SO-8, TO-220-5 and TO-263-5 are available with 1.8V and 2.5V internally preset outputs that are also adjustable using external resistors.

#### Features

- ◆ 350mV dropout @ 1.5A
- ◆ Adjustable output from 1.2V to 4.8V<sup>(1)</sup>
- ◆ 2.5V and 1.8V options (adjustable externally using resistors)<sup>(1)</sup>
- ◆ Over current and over temperature protection
- ◆ Enable pin<sup>(1)</sup>
- ◆ 10µA quiescent current in shutdown<sup>(1)</sup>
- ◆ Low reverse leakage (output to input)
- ◆ Surface mount and through-hole packages
- ◆ Full industrial temperature range
- ◆ TO-220, TO-263, SOT-223 and SO-8 Packages

#### Note:

(1) SO-8, TO-220-5 and TO-263-5 packages only.

#### Applications

- ◆ Battery powered systems
- ◆ Motherboards
- ◆ Peripheral cards
- ◆ Network cards
- ◆ Set Top Boxes
- ◆ Medical Equipment
- ◆ Notebook Computers

#### Typical Application Circuits

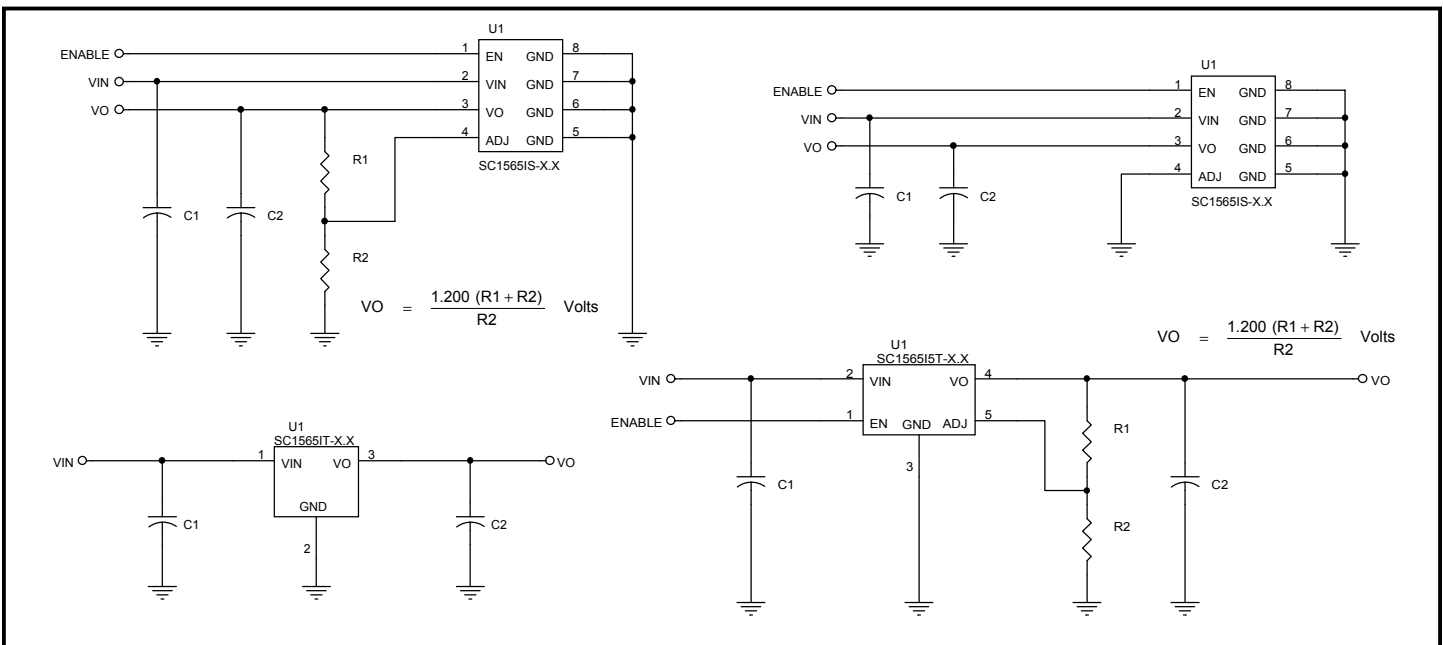

#### Notes:

- (1) Maximum VO setpoint for 1.8V parts = 5.4V.
- (2) This device is designed to operate with ceramic input and output capacitors.

**POWER MANAGEMENT**
**Absolute Maximum Ratings**

Exceeding the specifications below may result in permanent damage to the device, or device malfunction. Operation outside of the parameters specified in the Electrical Characteristics section is not implied.

Parameter	Symbol	Max	Units
Input Voltage	$V_{IN}$	7	V
Power Dissipation	$P_D$	Internally Limited	W
Thermal Resistance Junction to Ambient SO-8 <sup>(1)</sup> SOT-223 TO-220-X TO-263-X	$\theta_{JA}$	65 63 50 60	°C/W
Thermal Resistance Junction to Case SO-8 SOT-223 TO-220-X, TO-263-X	$\theta_{JC}$	39 27 3	°C/W
Operating Ambient Temperature Range	$T_A$	-40 to +85	°C
Operating Junction Temperature Range	$T_J$	-40 to +150	°C
Storage Temperature Range	$T_{STG}$	-65 to +150	°C
Lead Temperature (Soldering) 10 Sec.	$T_{LEAD}$	300	°C
ESD Rating (Human Body Model)	$V_{ESD}$	4	kV

**Note:** (1) 1 square inch of FR-4, double sided, 1 oz. minimum copper weight.

**Electrical Characteristics**

Unless specified:  $V_{EN} = V_{IN}$ . Adjustable Option ( $V_{ADJ} > V_{TH(ADJ)}$ ):  $V_{IN} = 2.2V$  to 5.5V and  $I_O = 10\mu A$  to 1.5A.

Fixed Options ( $V_{ADJ} = GND$ ):  $V_{IN} = (V_O + 0.7V)$  to 5.5V and  $I_O = 0A$  to 1.5A. Values in **bold** apply over the full operating temperature range.

Parameter	Symbol	Test Conditions	Min	Typ	Max	Units
<b>VIN</b>						
Supply Voltage Range	$V_{IN}$		<b>2.2</b>		<b>5.5</b>	V
Quiescent Current	$I_Q$	$V_{IN} = 3.3V$		0.75	<b>1.75</b>	mA
		$V_{IN} = 5.5V, V_{EN} = 0V$		10	<b>35</b>	$\mu A$
<b>VO</b>						
Output Voltage <sup>(1)</sup> (Internal Fixed Voltage)	$V_O$	$V_{IN} = V_O + 0.7V, I_O = 10mA$	-1%	$V_O$	+1%	V
			-2%		+2%	
Line Regulation <sup>(1)</sup>	$REG_{(LINE)}$	$V_{IN} = (V_O + 0.25V)$ to 5.5V, $I_{OUT} = 10mA$		0.035	<b>0.3</b>	%
Load Regulation <sup>(1)</sup>	$REG_{(LOAD)}$	$V_{IN} = V_O + 0.7V$		0.2	<b>0.4</b>	%
Dropout Voltage <sup>(1)(2)</sup>	$V_D$	$I_O = 10mA$		2.5	10	mV
					<b>20</b>	
					$I_O = 500mA$	
					<b>400</b>	

**POWER MANAGEMENT**
**Electrical Characteristics (Cont.)**

Unless specified:  $V_{EN} = V_{IN}$ . Adjustable Option ( $V_{ADJ} > V_{TH(ADJ)}$ ):  $V_{IN} = 2.2V$  to  $5.5V$  and  $I_O = 10\mu A$  to  $1.5A$ .

Fixed Options ( $V_{ADJ} = GND$ ):  $V_{IN} = (V_O + 0.7V)$  to  $5.5V$  and  $I_O = 0A$  to  $1.5A$ . Values in **bold** apply over the full operating temperature range.

Parameter	Symbol	Test Conditions	Min	Typ	Max	Units
<b>VO (Cont.)</b>						
Dropout Voltage <sup>(1)(2)</sup>		$I_O = 1A$		180	400	mV
					<b>500</b>	
		$I_O = 1.5A$		270	500	mV
					<b>600</b>	
Minimum Load Current <sup>(3)</sup>	$I_O$	$V_{IN} = V_O + 0.7V$		1	<b>10</b>	$\mu A$
Current Limit	$I_{CL}$		<b>1.6</b>	2.0	<b>3.5</b>	A
<b>ADJ</b>						
Reference Voltage <sup>(1)</sup>	$V_{REF}$	$V_{IN} = 2.2V, V_{ADJ} = V_{OUT}, I_O = 10mA$	1.188	1.200	1.212	V
			<b>1.176</b>		<b>1.224</b>	
Adjust Pin Current <sup>(4)</sup>	$I_{ADJ}$	$V_{ADJ} = V_{REF}$		30	<b>200</b>	nA
Adjust Pin Threshold <sup>(5)</sup>	$V_{TH(ADJ)}$		<b>0.05</b>	0.20	<b>0.40</b>	V
<b>EN</b>						
Enable Pin Current	$I_{EN}$	$V_{EN} = 0V, V_{IN} = 3.3V$		1.5	<b>10</b>	$\mu A$
Enable Pin Threshold	$V_{IH}$	$V_{IN} = 3.3V$	<b>1.6</b>			V
	$V_{IL}$	$V_{IN} = 3.3V$			<b>0.4</b>	
<b>Over Temperature Protection</b>						
High Trip level	$T_{HI}$			170		$^{\circ}C$
Hysteresis	$T_{HYST}$			20		$^{\circ}C$

**Notes:**

(1) Low duty cycle pulse testing with Kelvin connections required.

(2) Defined as the input to output differential at which the output voltage drops to 1% below the value measured at a differential of 0.7V.

(3) Required to maintain regulation. Voltage set resistors R1 and R2 are usually utilized to meet this requirement. Adjustable versions only.

(4) Guaranteed by design.

(5) When  $V_{ADJ}$  exceeds this threshold, the "Sense Select" switch disconnects the internal feedback chain from the error amplifier and connects  $V_{ADJ}$  instead.

**POWER MANAGEMENT**

**Pin Configurations**

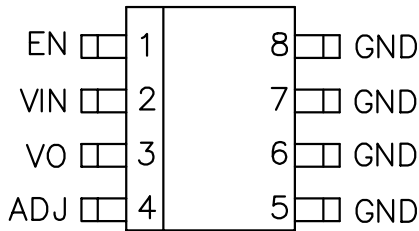

**SO-8**

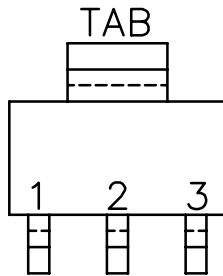

**SOT-223**

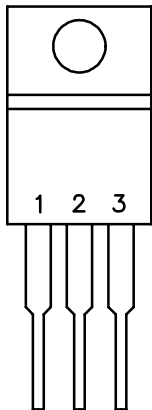

**TO-220-3**

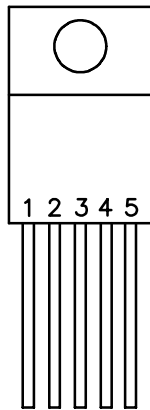

**TO-220-5**

SOT-223, TO-220-3 and TO-263-3	
PIN	FUNCTION
1	VIN
2	GND
3	VO
TAB is GND	

TO-220-5 and TO-263-5	
PIN	FUNCTION
1	EN
2	VIN
3	GND
4	VO
5	ADJ
TAB is GND	

**Ordering Information**

Device	Package
SC1565IS-X.XTR <sup>(1)(3)</sup>	SO-8
SC1565IS-X.XTRT <sup>(1)(3)(6)</sup>	
SC1565IST-X.XTR <sup>(2)(3)</sup>	SOT-223
SC1565IST-XXTRT <sup>(2)(3)(6)</sup>	
SC1565IM-X.XTR <sup>(2)(4)</sup>	TO-263-3
SC1565IM-XXTRT <sup>(2)(4)(6)</sup>	
SC1565I5M-X.XTR <sup>(1)(4)</sup>	TO-263-5
SC1565I5MX.XTRT <sup>(1)(4)(6)</sup>	
SC1565IT-X.X <sup>(2)(5)</sup>	TO-220-3
SC1565IT-X.XT <sup>(2)(5)(6)</sup>	
SC1565I5T-X.X <sup>(1)(5)</sup>	TO-220-5
SC1565I5T-X.XT <sup>(1)(5)(6)</sup>	

**Notes:**

- (1) Where -X.X denotes voltage options. Available voltages are: 2.5V and 1.8V. Output voltage can be adjusted using external resistors, see Pin Descriptions on page 5.
- (2) Where -X.X denotes voltage options. Available voltages are: 2.5V and 1.8V. Output not adjustable.
- (3) Only available in tape and reel packaging. A reel contains 2500 devices.
- (4) Only available in tape and reel packaging. A reel contains 800 devices.
- (5) Only available in tube packaging. A tube contains 50 devices.
- (6) Lead free product. This product is fully WEEE and RoHS compliant.

**Pin Configurations (Cont.)**

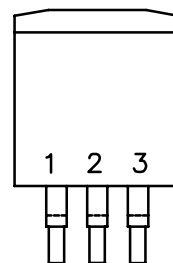

**TO-263-3**

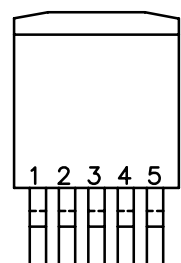

**TO-263-5**

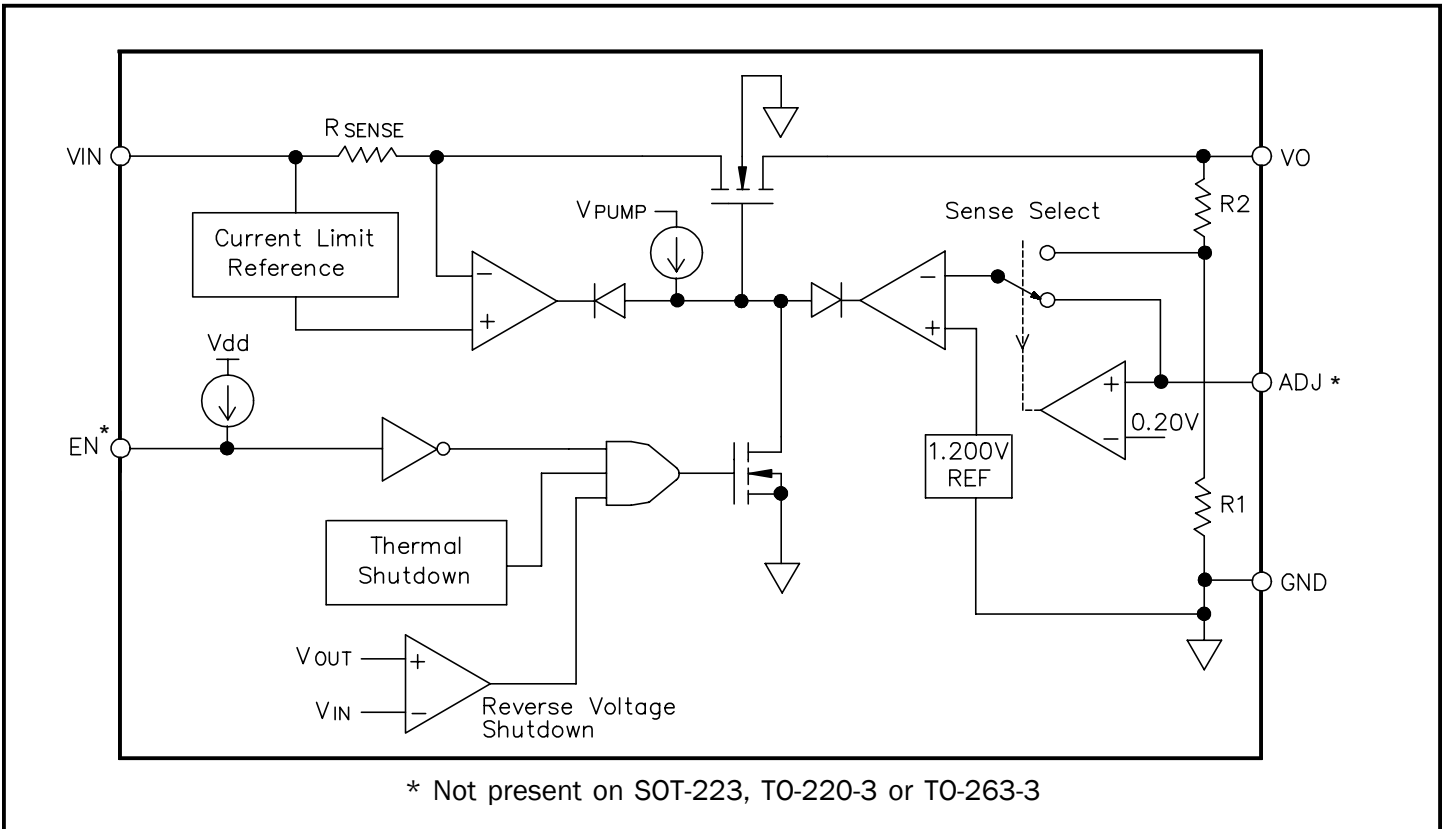
**POWER MANAGEMENT**
**Block Diagram**

**Pin Descriptions**

Pin Name	Pin Description
ADJ	This pin, when grounded, sets the output voltage to that set by the internal feedback resistors. If external feedback resistors are used, the output voltage will be (See Application Circuits on page 1): $V_O = \frac{1.200 (R_1 + R_2)}{R_2} \text{ Volts}$
EN	Enable Input. Pulling this pin below 0.4V turns the regulator off, reducing the quiescent current to a fraction of its operating value. The device will be enabled if this pin is left open. Connect to VIN if not being used.
GND	Reference ground. Use all four pins on the SO-8 device for heatsinking. Use the tab on the SOT-223, TO-220 and TO-263 devices for heatsinking.
VIN	Input voltage. For regulation at full load, the input to this pin must be between $(V_O + 0.7V)$ and 5.5V. Minimum $V_{IN} = 2.2V$ .
VO	The pin is the power output of the device.

**POWER MANAGEMENT**

**Typical Characteristics**

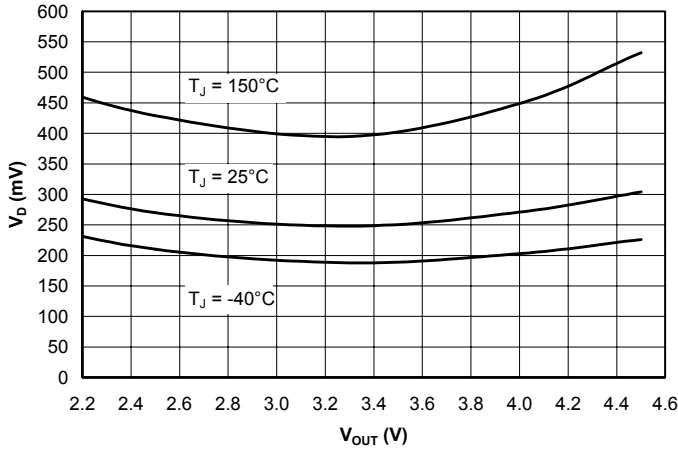
**Dropout Voltage ( $I_{OUT} = 1.5A$ ) vs. Output Voltage vs. Junction Temperature**



**Dropout Voltage ( $I_{OUT} = 1A$ ) vs. Output Voltage vs. Junction Temperature**

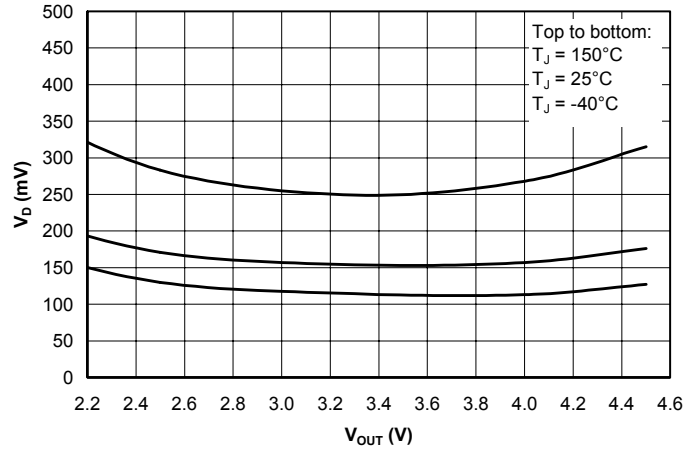

**Dropout Voltage ( $I_{OUT} = 0.5A$ ) vs. Output Voltage vs. Junction Temperature**

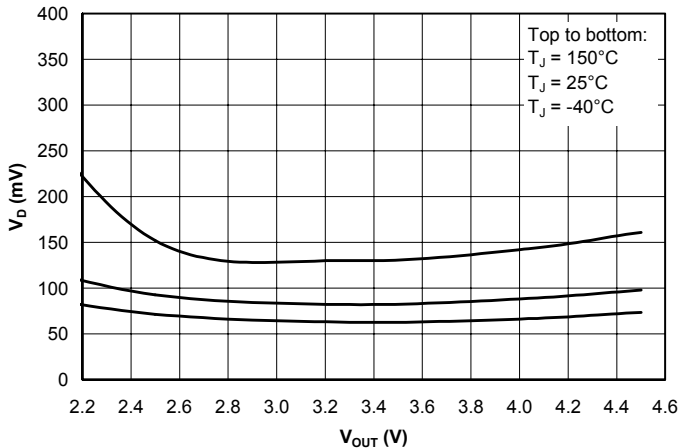

**Output Voltage (2.5V) vs. Junction Temperature vs. Output Current**

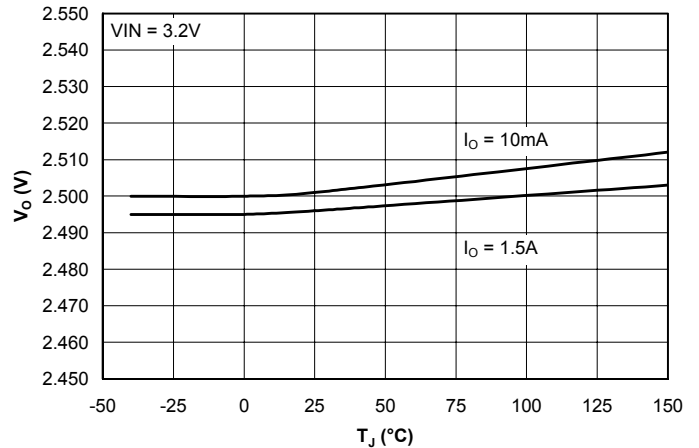

**Output Voltage (2.5V) vs. Junction Temperature vs. Output Current**

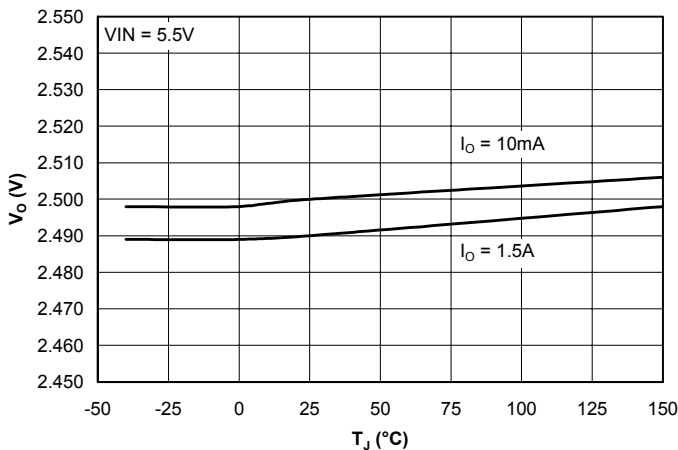

**Reference Voltage vs. Junction Temperature vs. Output Current**

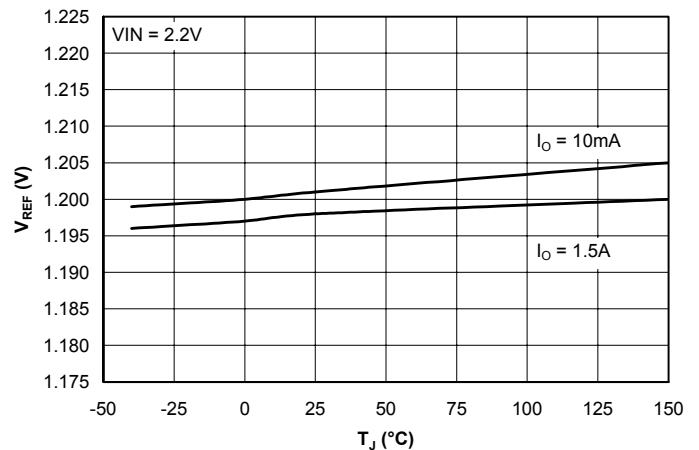

**POWER MANAGEMENT**

**Typical Characteristics (Cont.)**

**Reference Voltage vs. Junction Temperature vs. Output Current**

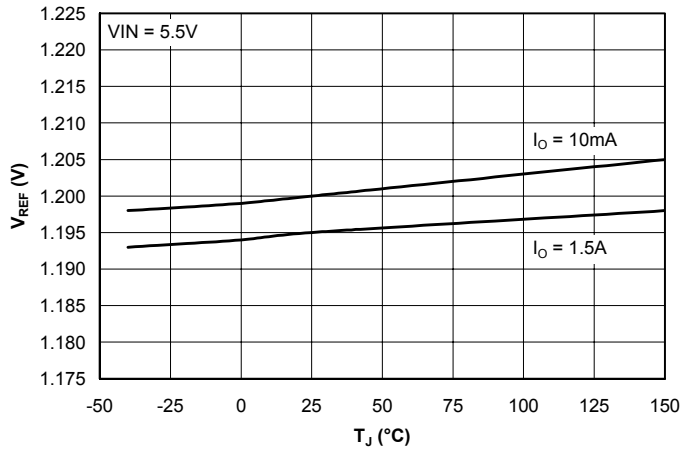

**Quiescent Current vs. Junction Temperature**

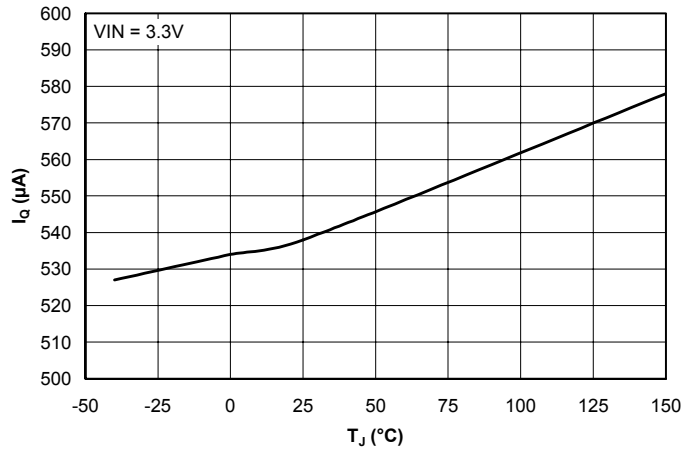

**Off-State Quiescent Current vs. Junction Temperature**

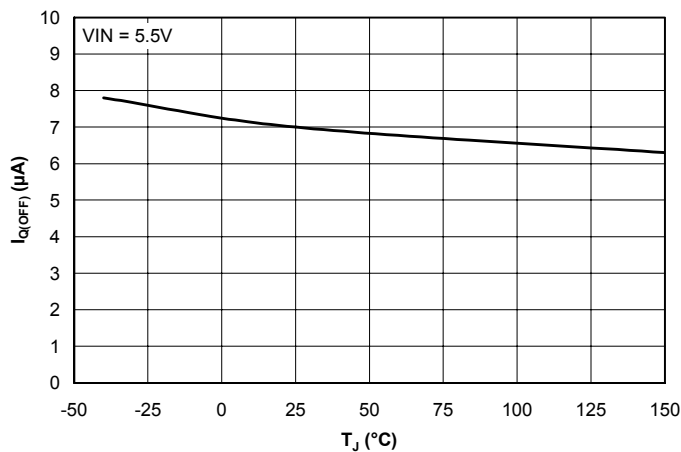

**POWER MANAGEMENT**
**Applications Information**
**Introduction**

The SC1565 is intended for applications such as graphics cards where high current capability and very low dropout voltage are required. It provides a very simple, low cost solution that uses very little pcb real estate. Additional features include an enable pin to allow for a very low power consumption standby mode, and a fully adjustable output.

**Component Selection**

**Input capacitor:** a 4.7 $\mu$ F ceramic capacitor is recommended. This allows for the device being some distance from any bulk capacitance on the rail. Additionally, input droop due to load transients is reduced, improving load transient response. Additional capacitance may be added if required by the application.

**Output capacitor:** a minimum bulk capacitance of 2.2 $\mu$ F, along with a 0.1 $\mu$ F ceramic decoupling capacitor is recommended. Increasing the bulk capacitance will improve the overall transient response. The use of multiple lower value ceramic capacitors in parallel to achieve the desired bulk capacitance will not cause stability issues. Although designed for use with ceramic output capacitors, the SC1565 is extremely tolerant of output capacitor ESR values and thus will also work comfortably with tantalum output capacitors. For reference, the phase-margin contour of Figure 1 can be used to choose an appropriate output capacitor for a given stability requirement.

**Noise immunity:** in very electrically noisy environments, it is recommended that 0.1 $\mu$ F ceramic capacitors be placed from IN to GND and OUT to GND as close to the device pins as possible.

**External voltage selection resistors:** the use of 1% resistors, and designing for a current flow  $\geq 10\mu$ A is recommended to ensure a well regulated output (thus  $R2 \leq 120k\Omega$ ).

**Thermal Considerations**

The power dissipation in the SC1565 is approximately equal to the product of the output current and the input to output voltage differential:

$$P_D \approx (V_{IN} - V_{OUT}) \cdot I_O$$

The absolute worst-case dissipation is given by:

$$P_{D(MAX)} = (V_{IN(MAX)} - V_{OUT(MIN)}) \cdot I_{O(MAX)} + V_{IN(MAX)} \cdot I_{Q(MAX)}$$

For a typical scenario,  $V_{IN} = 3.3V \pm 5\%$ ,  $V_{OUT} = 2.8V$  and  $I_O = 1.5A$ , therefore:

$$V_{IN(MAX)} = 3.465V, V_{OUT(MIN)} = 2.744V \text{ and } I_{Q(MAX)} = 1.75mA,$$

$$\text{Thus } P_{D(MAX)} = 1.09W.$$

Using this figure, and assuming  $T_{A(MAX)} = 70^\circ C$ , we can calculate the maximum thermal impedance allowable to maintain  $T_J \leq 150^\circ C$ :

$$R_{TH(J-A)(MAX)} = \frac{(T_{J(MAX)} - T_{A(MAX)})}{P_{D(MAX)}} = \frac{(150 - 70)}{1.09} = 73.4^\circ C / W$$

This should be achievable for the SO-8 package using pcb copper area to aid in conducting the heat away, such as one square inch of copper connected to the ground pins of the device. The SOT-223, TO-220 and TO-263 packages would not require heatsinking. Internal ground/power planes and air flow will also assist in removing heat. For higher ambient temperatures it may be necessary to use additional copper area.



**POWER MANAGEMENT**
**Applications Information (Cont.)**

Figure 1: Phase-margin Contour Plot

**POWER MANAGEMENT**

**Outline Drawing - SO-8**

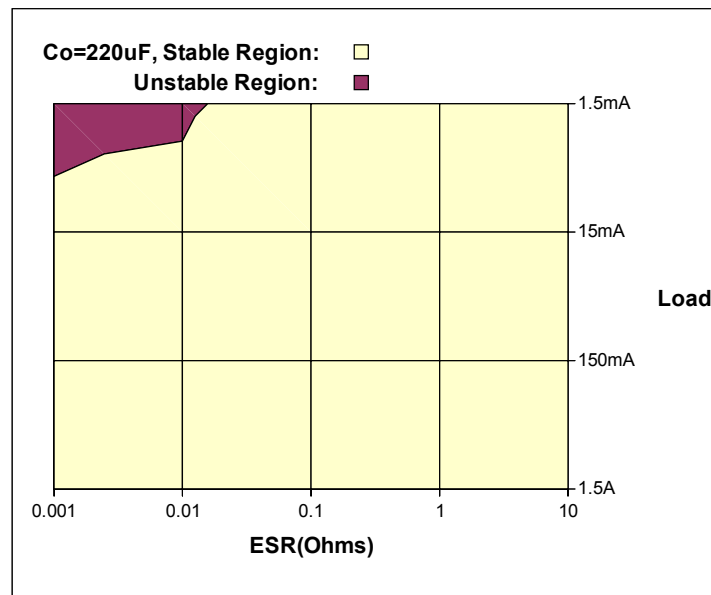
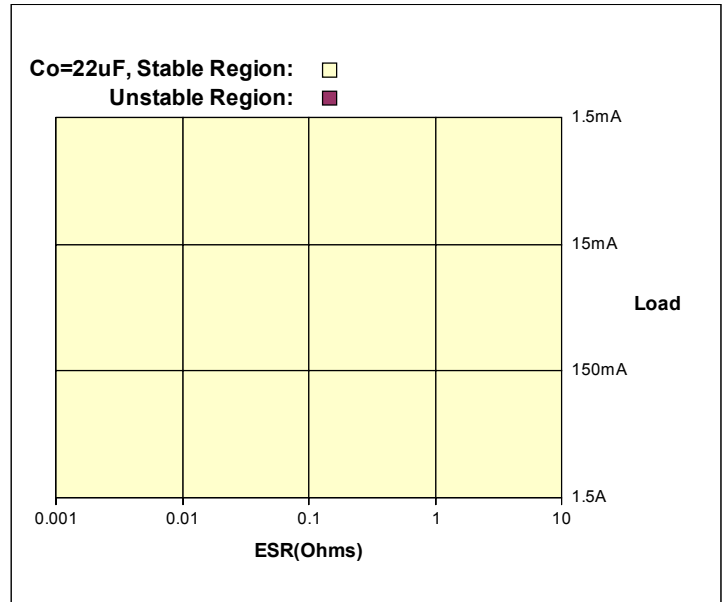
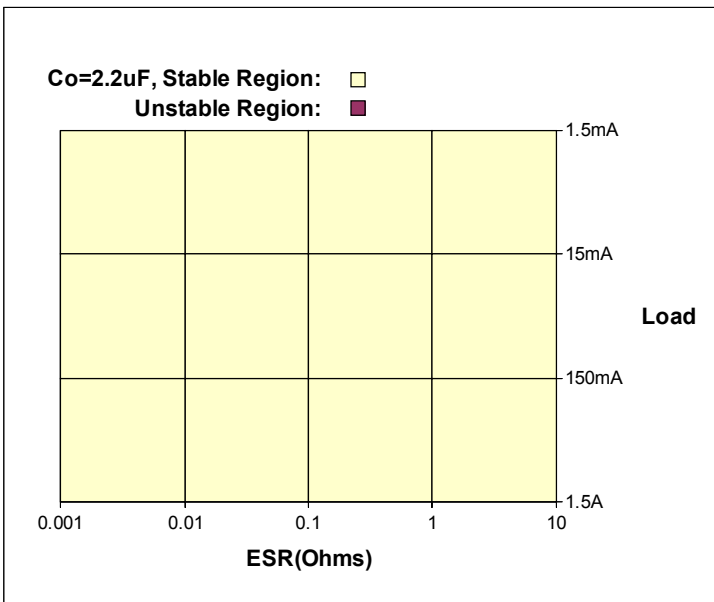
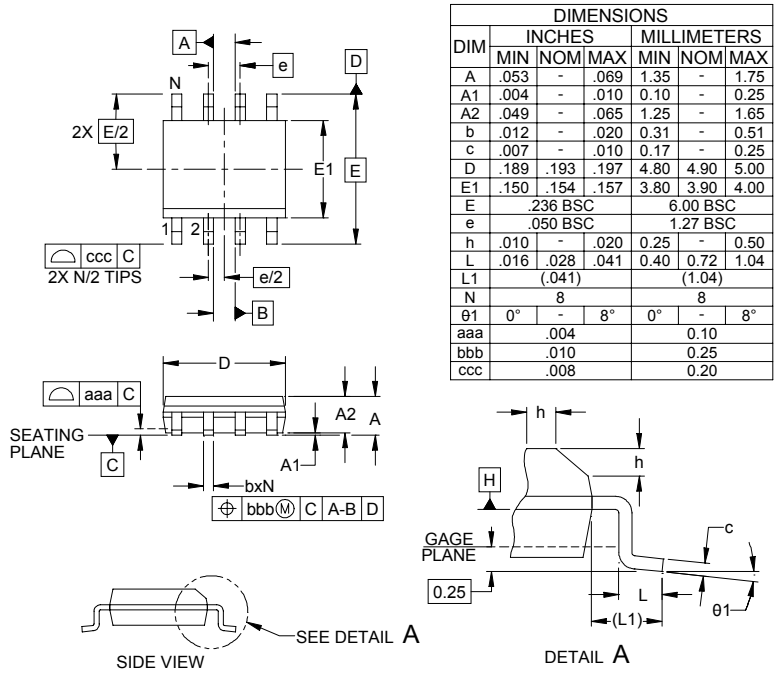

DIM	INCHES			MILLIMETERS		
	MIN	NOM	MAX	MIN	NOM	MAX
A	.053	-	.069	1.35	-	1.75
A1	.004	-	.010	0.10	-	0.25
A2	.049	-	.065	1.25	-	1.65
b	.012	-	.020	0.31	-	0.51
c	.007	-	.010	0.17	-	0.25
D	.189	.193	.197	4.80	4.90	5.00
E1	.150	.154	.157	3.80	3.90	4.00
E	.236 BSC			6.00 BSC		
e	.050 BSC			1.27 BSC		
h	.010	-	.020	0.25	-	0.50
L	.016	.028	.041	0.40	0.72	1.04
L1	(.041)			(1.04)		
N	8			8		
theta1	0°	-	8°	0°	-	8°
aaa	.004			0.10		
bbb	.010			0.25		
ccc	.008			0.20		

- NOTES:
1. CONTROLLING DIMENSIONS ARE IN MILLIMETERS (ANGLES IN DEGREES).
  2. DATUMS **-A-** AND **-B-** TO BE DETERMINED AT DATUM PLANE **-H-**
  3. DIMENSIONS "E1" AND "D" DO NOT INCLUDE MOLD FLASH, PROTRUSIONS OR GATE BURRS.
  4. REFERENCE JEDEC STD MS-012, VARIATION AA.

**Land Pattern - SO-8**

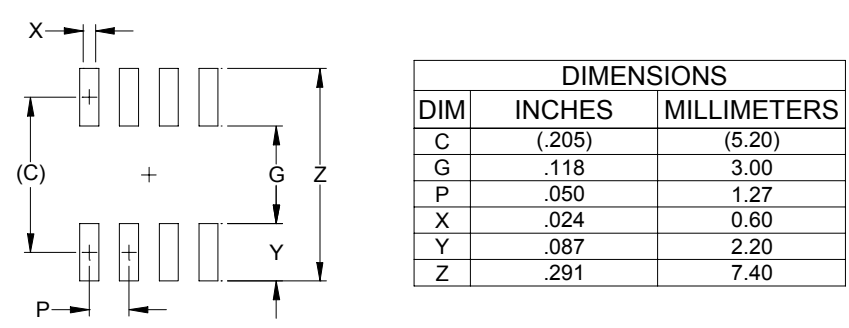

DIM	INCHES	MILLIMETERS
C	(.205)	(5.20)
G	.118	3.00
P	.050	1.27
X	.024	0.60
Y	.087	2.20
Z	.291	7.40

- NOTES:
1. THIS LAND PATTERN IS FOR REFERENCE PURPOSES ONLY. CONSULT YOUR MANUFACTURING GROUP TO ENSURE YOUR COMPANY'S MANUFACTURING GUIDELINES ARE MET.
  2. REFERENCE IPC-SM-782A, RLP NO. 300A.

**POWER MANAGEMENT**

**Outline Drawing - SOT-223**

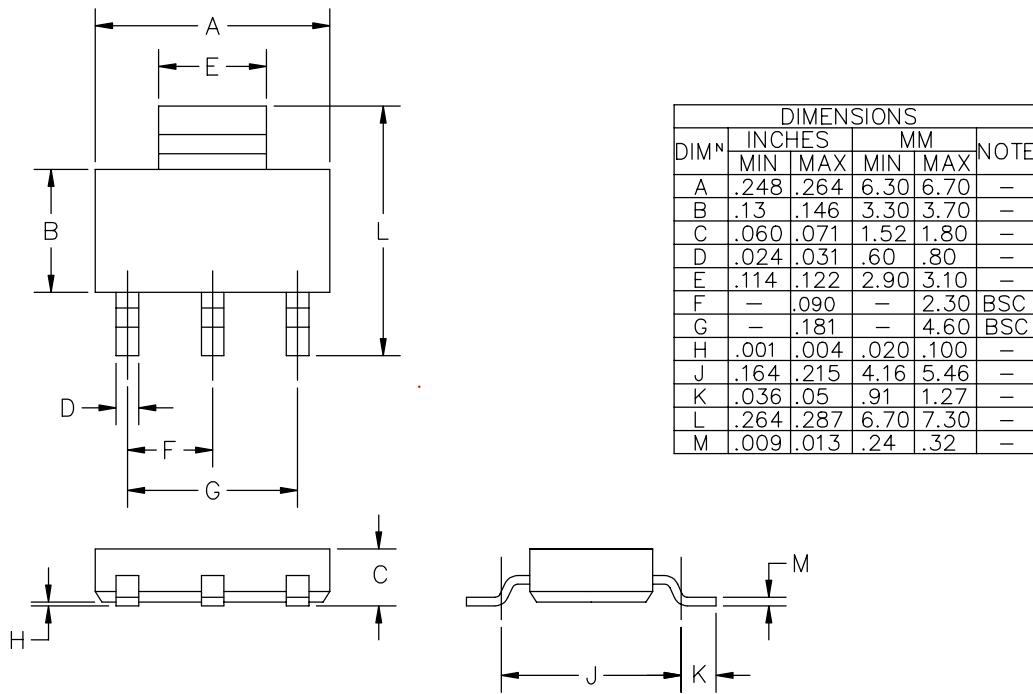

CONTROLLING DIMENSIONS: MILLIMETERS.

**Land Pattern - SOT-223**

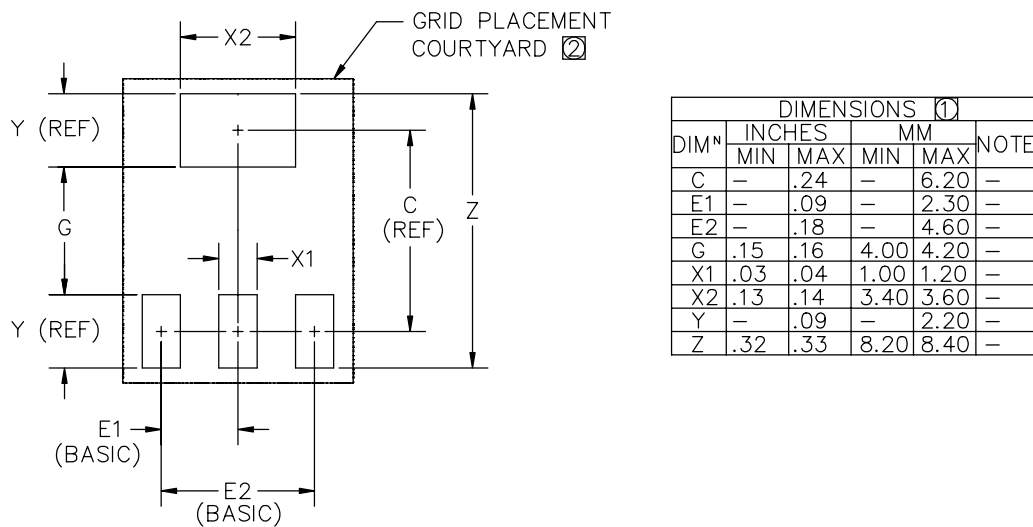

② GRID PLACEMENT COURTYARD IS 18 x 14 ELEMENTS (9 mm X 7mm) IN ACCORDANCE WITH THE INTERNATIONAL GRID DETAILED IN IEC PUBLICATION 97.

① CONTROLLING DIMENSION: MILLIMETERS

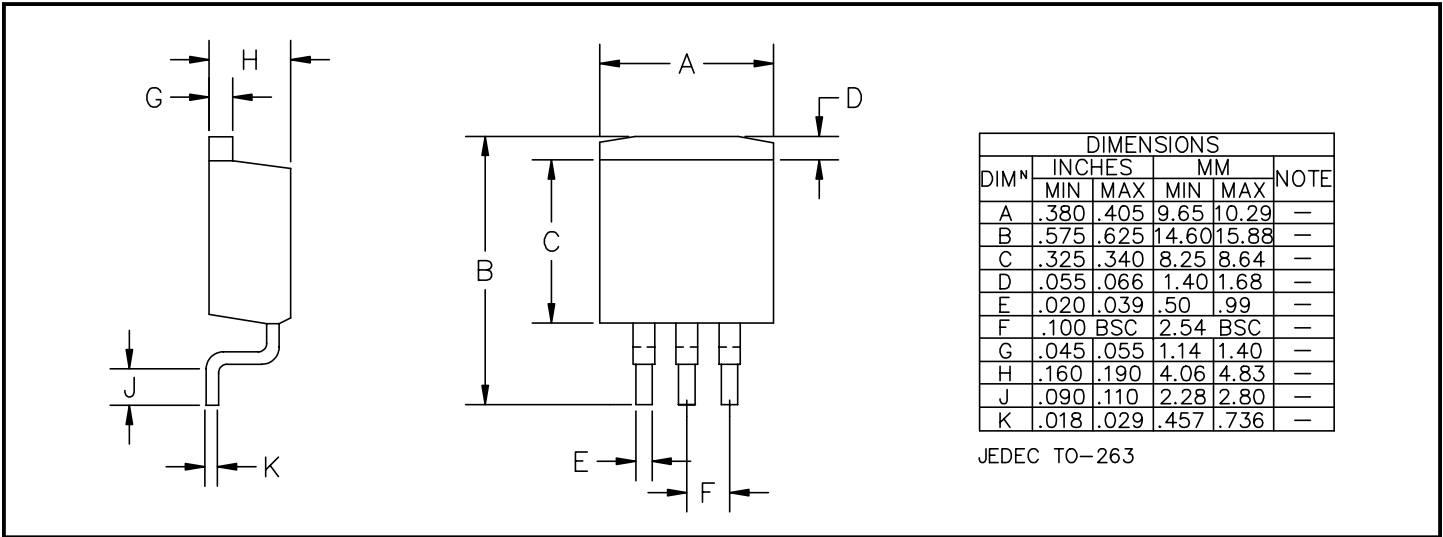
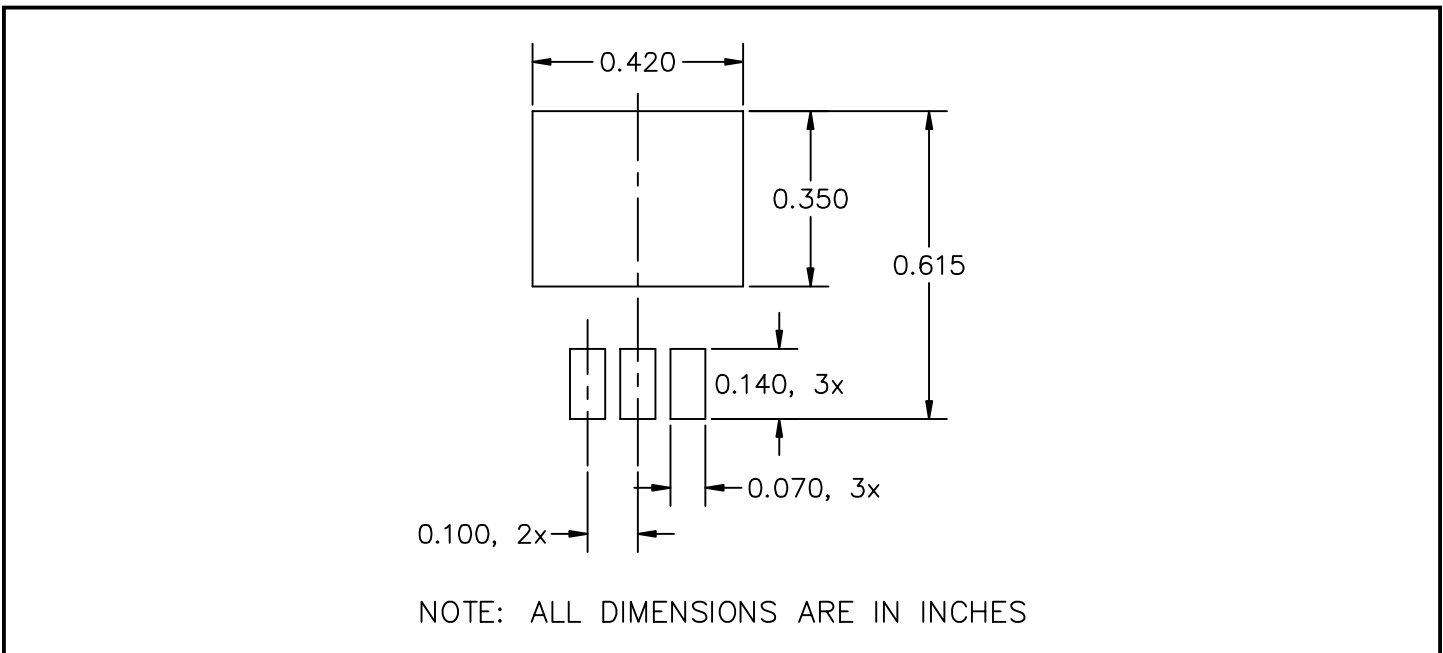
**POWER MANAGEMENT**
**Outline Drawing - T0-263-3**

**Minimum Land Pattern - T0-263-3**

**POWER MANAGEMENT**

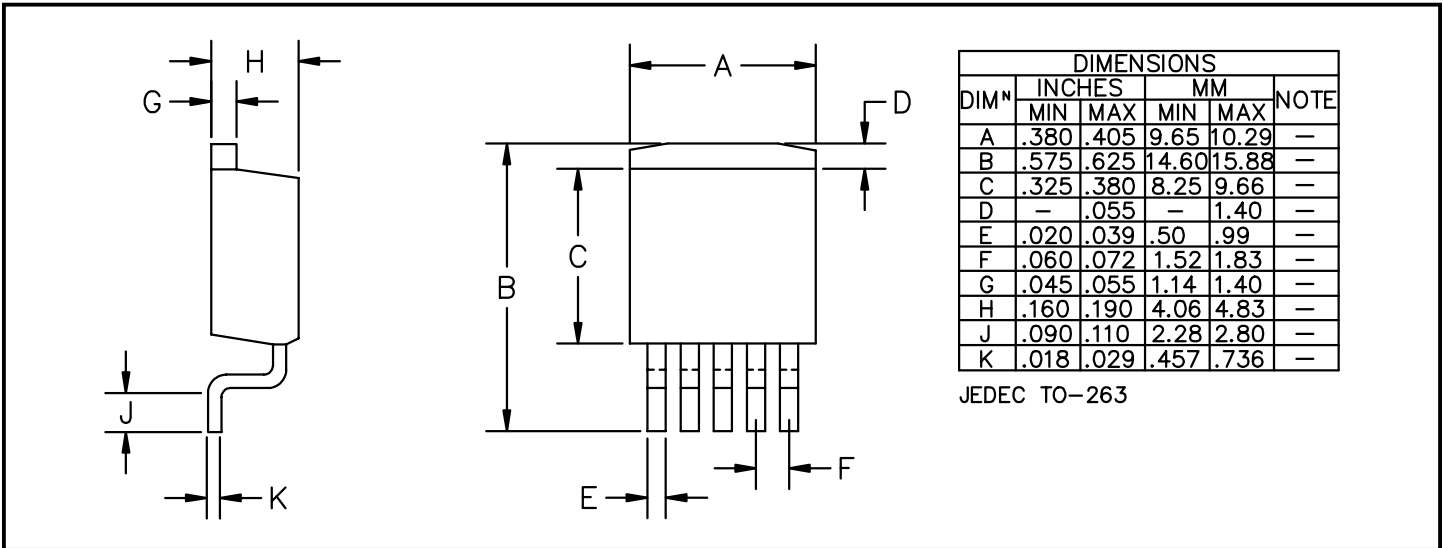
**Outline Drawing - T0-263-5**

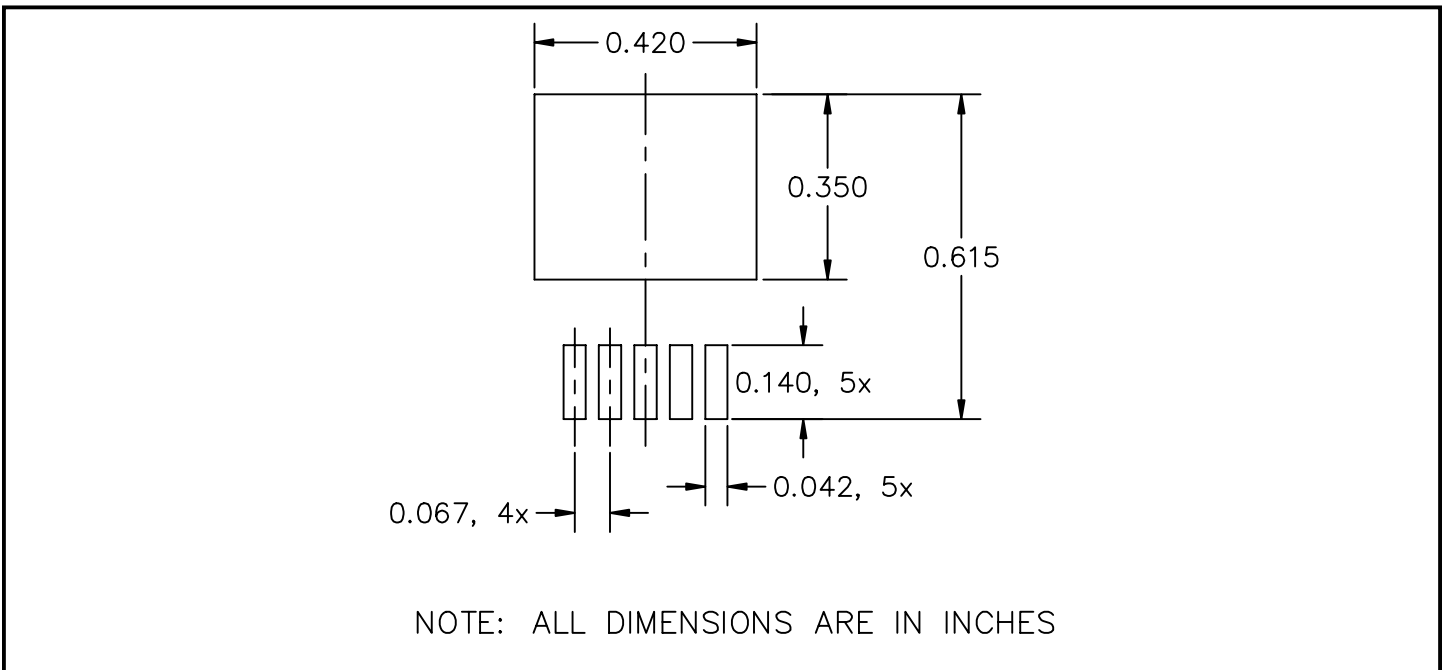

**Minimum Land Pattern - T0-263-5**



**POWER MANAGEMENT**

**Outline Drawing - TO-220-3**

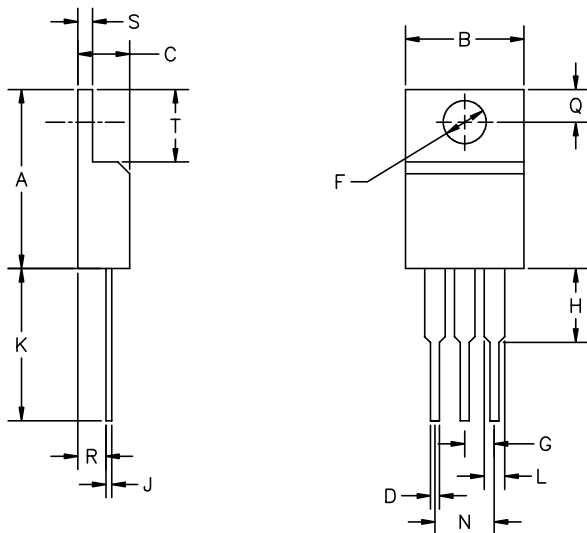

DIM <sup>N</sup>	DIMENSIONS				NOTE
	INCHES		MM		
	MIN	MAX	MIN	MAX	
A	.560	.650	14.23	16.51	
B	.380	.420	9.66	10.66	
C	.140	.190	3.56	4.82	
D	.020	.045	0.51	1.14	
F	.139	.161	3.54	4.08	
G	.090	.110	2.29	2.79	
H	—	.250	—	6.35	
J	.012	.045	.31	1.14	
K	.500	.580	12.70	14.73	
L	.045	.070	1.15	1.77	
N	.190	.210	4.83	5.33	
Q	.100	.135	2.54	3.42	
R	.080	.115	2.04	2.92	
S	.020	.055	.51	1.39	
T	.230	.270	5.85	6.85	

JEDEC TO-220

**Outline Drawing - TO-220-5**

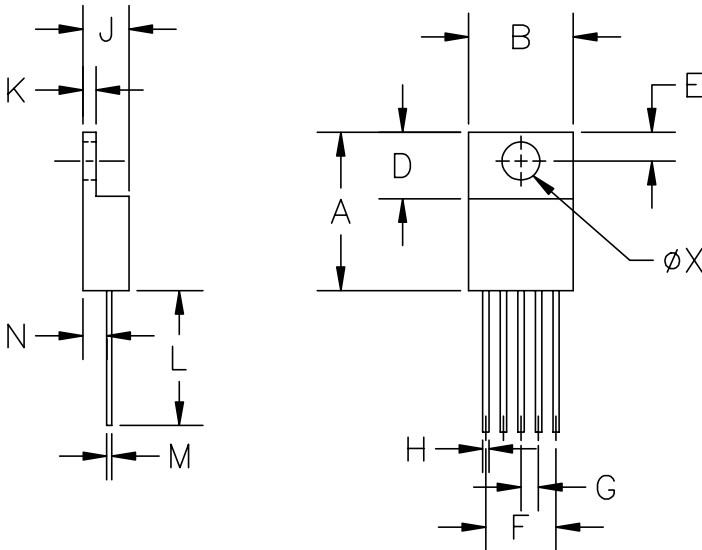

DIM <sup>N</sup>	DIMENSIONS				NOTE
	INCHES		MM		
	MIN	MAX	MIN	MAX	
A	.560	.650	14.22	16.51	—
B	.380	.420	9.65	10.67	—
D	.230	.260	5.84	6.60	—
E	.100	.135	2.54	3.43	—
F	.263	.273	6.68	6.94	—
G	.062	.072	1.57	1.83	—
H	.025	.040	.63	1.02	—
J	.140	.190	3.55	4.83	—
K	.045	.055	1.14	1.40	—
L	.540	.560	13.72	14.22	—
M	.014	.022	.35	.56	—
N	.080	.120	2.03	3.05	—
ØX	.139	.161	3.53	4.09	—

JEDEC TO-220

**Contact Information**

Semtech Corporation  
 Power Management Products Division  
 200 Flynn Road, Camarillo, CA 93012  
 Phone: (805)498-2111 FAX (805)498-3804